

Thermally Insulated Doors

Energy-Saving, Weather-Resistant, Sound-Absorbing



3
THERMCORD



record

your global partner for entrance solutions

Contents

Energy saving	3
Security	5
Weather-Resistant	7
Noise Reduction	7
Thermally separated floor rail	8
Modularity	10

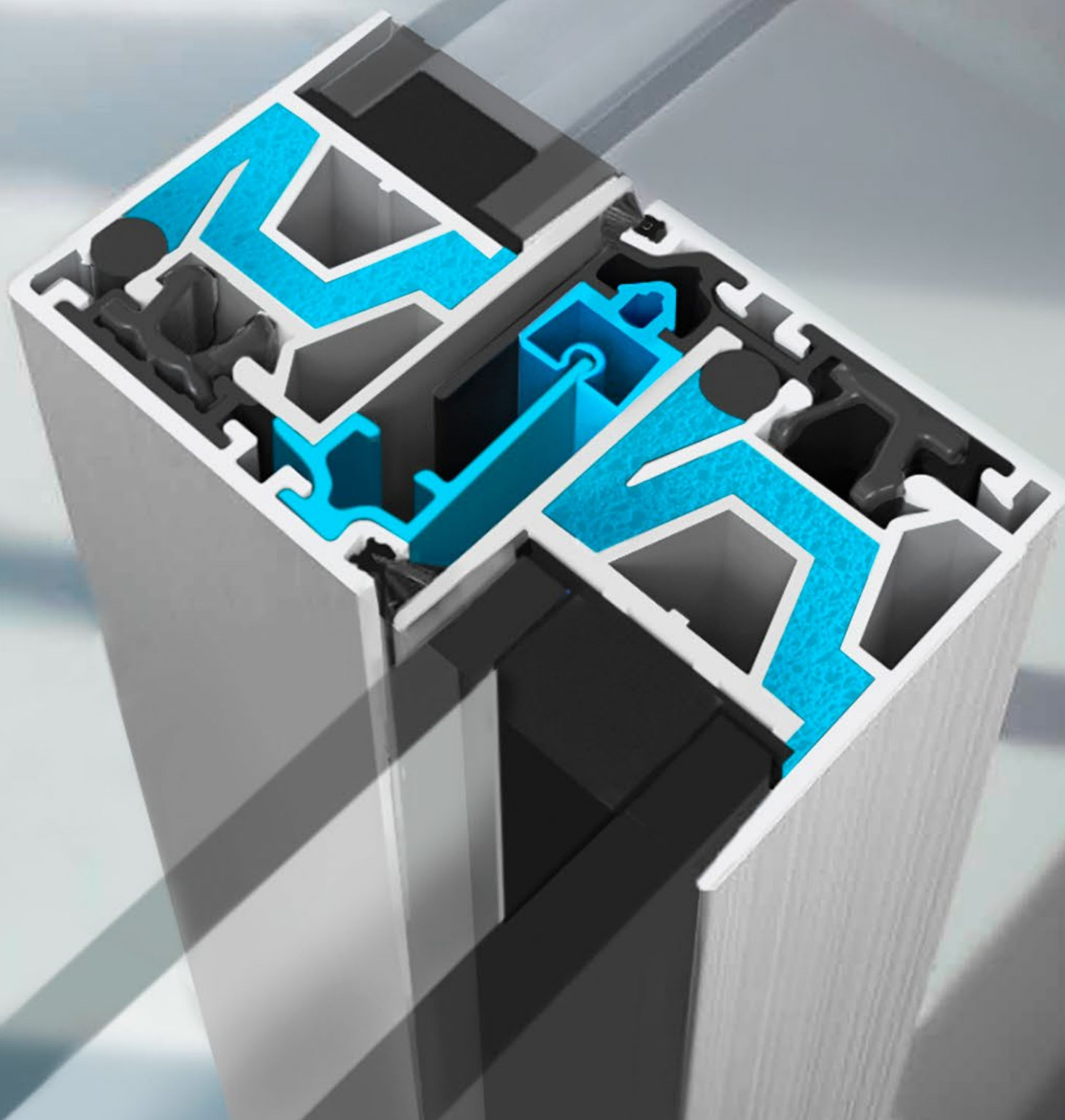

Energy saving

The awareness of dealing responsibly with natural resources is also reflected in the requirements on buildings and their elements, such as windows and doors, and thus leads to a reduction in energy costs. Heat loss via walls and doors can be efficiently reduced by the automatic door system THERMCORD³ with complete thermal separation, from the panel and profile system to the thermally separated floor rail in the longitudinal axis.

Advantages:

- Effective thermal barrier from the panel and vertical profile to the floor rail
- Triple glazing to improve thermal insulation
- Unchanged series drives – therefore economical in maintenance and servicing

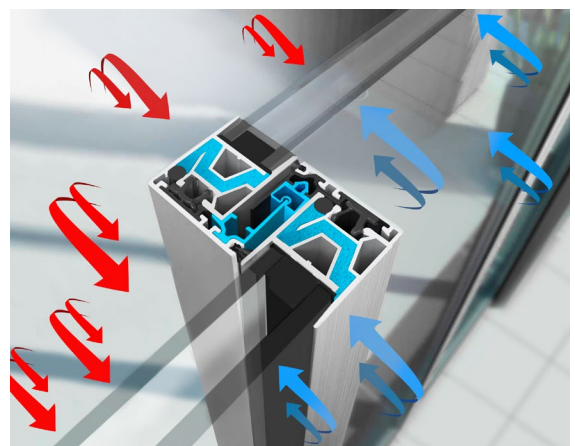

Door system with complete thermal separation from the panel and vertical profile to the floor rail.



BUCHERER
1888



Security

That which defies the meteorological elements can also withstand earthly forces. The entrance area, consisting of an external security door and a vestibule completely made of glass.

Bucherer Jewellery Shop, Switzerland



Monte Generoso, Switzerland

Weather-Resistant

The longitudinal profiles installed in the door leaves feature enormous rigidity with their structure-reinforcing double V-shape. This means that the movement of the door is largely unaffected by high wind loads, suction or pressure. As a further result of this rigidity, the clearances could be reduced, which in terms of avoiding draughts makes the THERMCORD³ superior to a conventional design already in the layout. Even driving rain with an intensity far exceeding the maximum defined category E 600,A is effectively repelled and protects your entrance area from weather damage.

THERMCORD ³		
Watertightness	E600,A	Outstanding watertightness to E600 Pa thanks to intelligent sealing system.
Air permeability	3/3/600	Less draught: tight when it has to be tight.
Direct airborne sound insulation value	35 dB sound insulation class 1 (DIN 4109)	With the record THERMCORD ³ we offer you sound insulation which, at up to - 35 dB, contributes greatly to a pleasant indoor climate.
Safety check	1270 Pa	Increased safety even at wind speeds of 150 km/h.
Resistance to wind load	PPD(600),A PPD(400),B PPD2,C	Staying dry even at hurricane-force winds (110 km/h).
Building closure	For new or recent buildings	With a compliant building closure, the complete closure of the building structure is made possible and thus the danger of moisture and wetness damaging the structural shell is minimised.

Noise Reduction

Thermal separation can also be used for acoustic separation and therefore have sound-insulating properties. Direct airborne sound insulation value 35 dB – quietness when quietness is required.

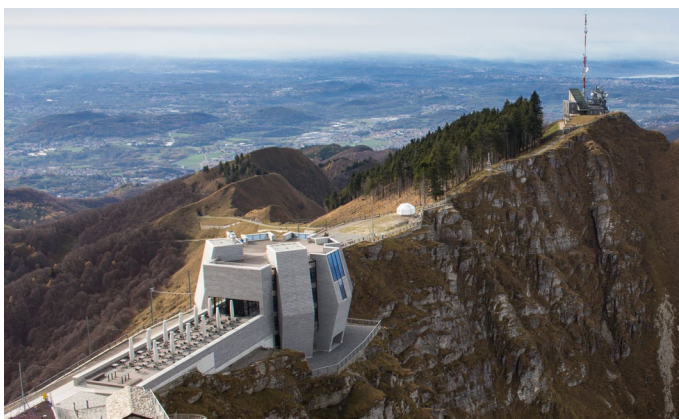
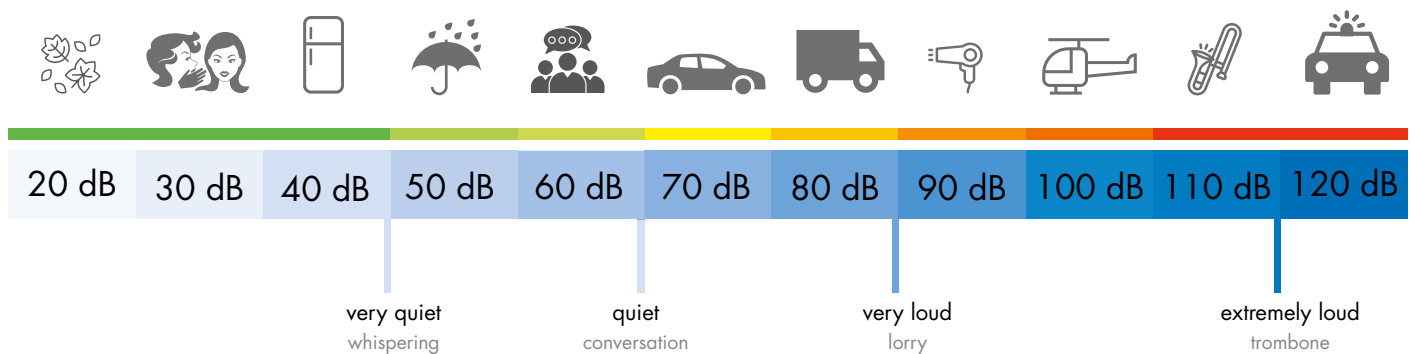

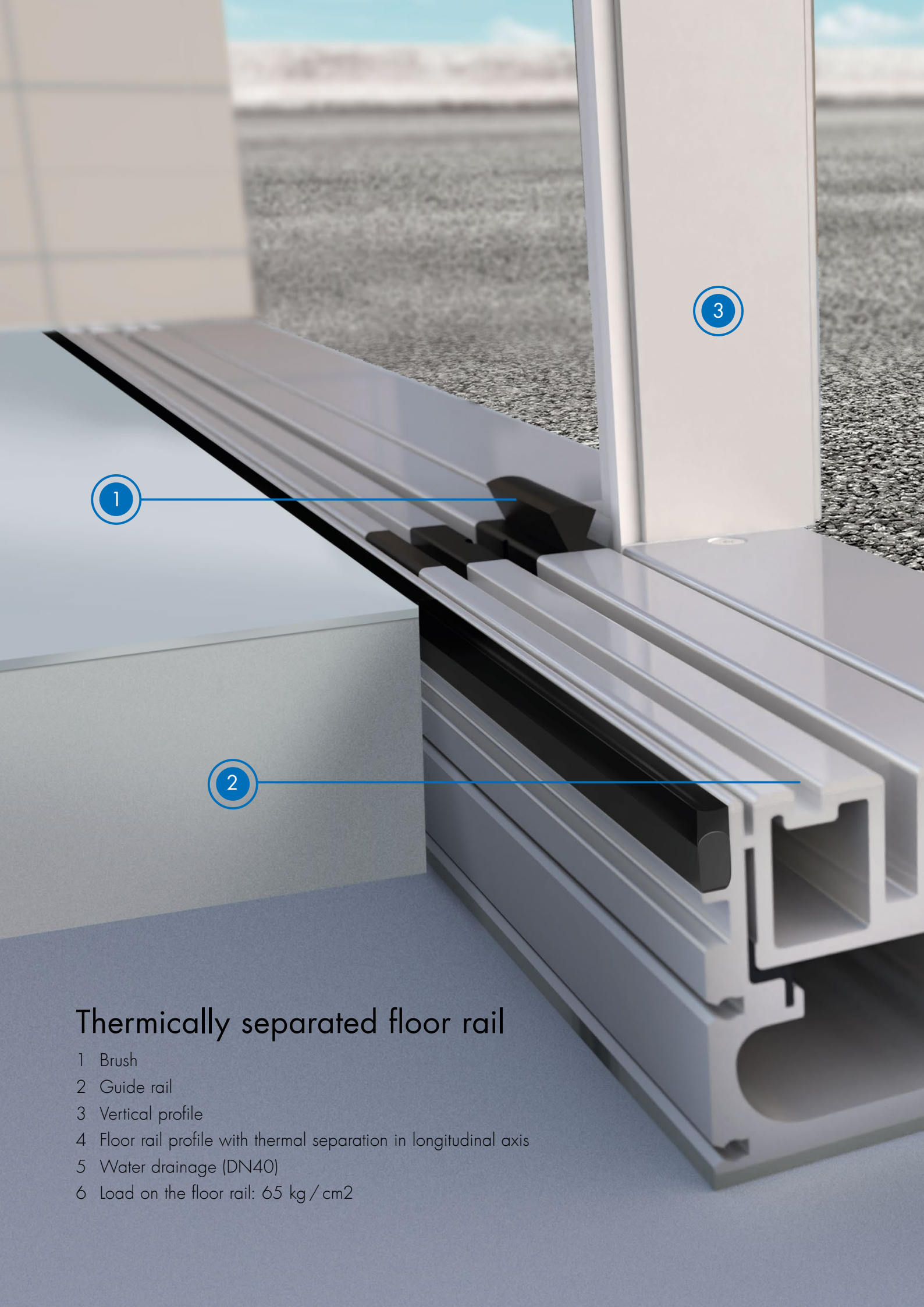

3

1

2

Thermally separated floor rail

- 1 Brush
- 2 Guide rail
- 3 Vertical profile
- 4 Floor rail profile with thermal separation in longitudinal axis
- 5 Water drainage (DN40)
- 6 Load on the floor rail: 65 kg/cm²

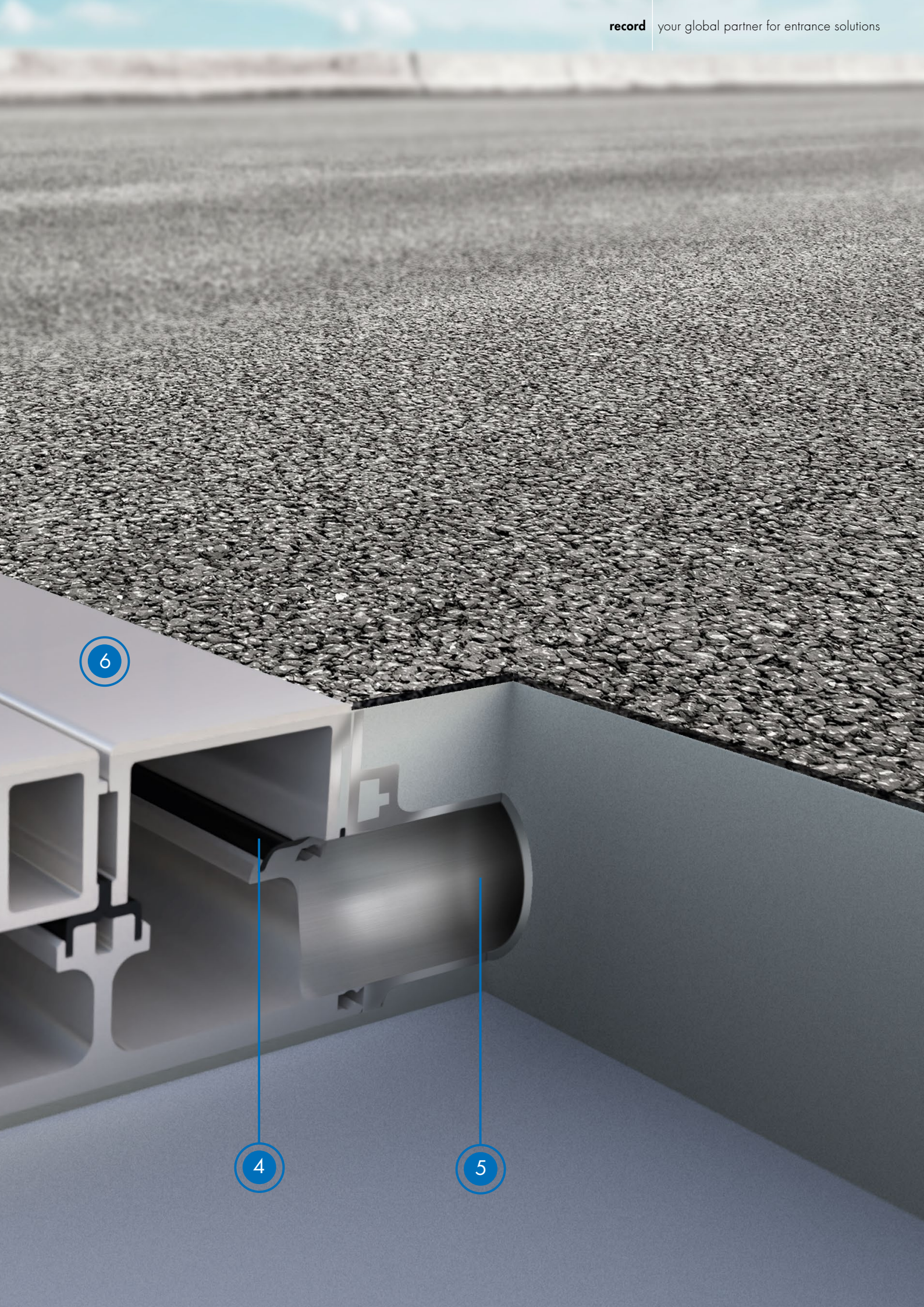

6

4

5

Modularity

More safety and efficiency for architects, planners and assembly fitters. When it comes to complex development and installation processes, the modular sealed system THERMCORD³ can help. The intelligent and modular profile system allows the door to become part of the façade. Wherever necessary, record supports you with CAD plans, material extracts and detailed plans to make planning as easy as possible for you.

The sliding door THERMCORD³ guarantees a compliant building closure for new or recent buildings.

- Installation of the thermally separated floor rail in longitudinal axis, profile system with support profile, ensuring that sealing is done according to the state of the art. Furthermore, installation of the profile system (frame / cassette system) directly during assembly of the body shell ensures that subsequent on-site tolerances do not affect the door.
- Installation of the drive, door leaf and also commissioning.

1

Project planning

Support and advice from our competent and experienced planning team



2

Purchase

Excellence from consulting to after sales service



3

Installation

Installation of the floor rail, building sealing and profiles



4

Completion

Commissioning and training by our qualified service personnel



Service

With our nationwide qualified service network we offer you the fastest possible support for door and gate systems. The i-record app supports the technician during service and maintenance work in an intuitive manner and contributes to rapid troubleshooting with an exact diagnostics of the entire door system. With the help function, remote support can also be requested online if required. Downloadable updates ensure a reliable and extended operation of the automatic door system. Our consultants will assist you in finding the right service package for your needs.

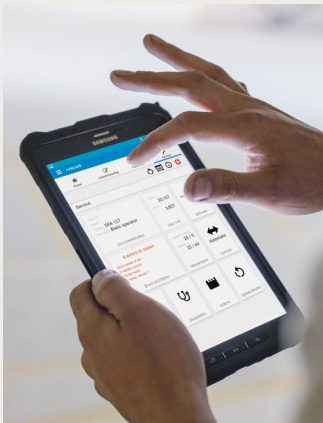

Maintenance

Periodic maintenance is indispensable to ensure that your automatic door functions perfectly for many years and that the safety regulations are complied with at the same time. Benefit from the variable services of the record maintenance agreements, which allow you to significantly reduce your own operating and maintenance costs.

U-value calculator



record AR App



record UK limited

Head Office
Unit D
9 Watt Place
Hamilton International Park
Blantyre
G72 0AH – UK

info@recorduk.co.uk
www.recorduk.co.uk

Northern Office
Unit 2, Shaw Cross Court
Horace Waller V C Parade
Shaw Cross Business Park
Dewsbury
WF12 7RF – UK

Midland Office
4th floor,
Townend House
Park Street, Walsall
WS1 1NS

Southern Office
17 Invincible Road –
Farnborough
GU14 7QU – UK

Headquartered in Switzerland, the record group sells its products and services across the globe and is directly present with subsidiaries in many countries.

Global sales and service contacts: www.record.group/countries

